

A mechanism for alkaline cell leakage

L. M. BAUGH, J. A. COOK, J. A. LEE

The Ever Ready Co. (Holdings) Ltd, Central Laboratories, St. Ann's Road, London N15 3TJ

Received 9 September 1977

A form of alkaline creepage, other than that governed by electrocapillary phenomena, has been studied on partially immersed negatively polarized electrodes. This extra-creepage is believed to result from concentration gradients generated in the thin spreading film above the intrinsic liquid meniscus by the electrochemical reduction of oxygen and/or water. Consequent transport of water into the spreading film allows it to expand and advance further along the electrode.

1. Introduction

Alkaline cells are particularly susceptible to electrolyte leakage with the creepage pathway invariably being along the negatively charged metal sealing surface (negative battery terminal). For example in nickel–cadmium cells the creeping surface is the nickel-plated can in contact with the cadmium anode, while in silver oxide button cells the tin copper, or gold-plated top cap in contact with the zinc anode affords the leakage pathway. Also, because the battery anode and the leakage surface are in contact they must be at the same electrical potential (mixed potential) and, since they are constructed of dissimilar metals, galvanic corrosion occurs. This takes the form of a cathodic electrochemical reduction of water and oxygen on the leakage surface with the corresponding anodic reaction being the dissolution of the anode material.

Despite the importance of cell leakage it is only very recently that a mechanism for such creepage has been presented. Hull and James [1] studied the advancement of a thin alkaline electrolyte film above the intrinsic meniscus on partially immersed electrodes of nickel and silver and from their results they concluded that the electrochemical reduction of oxygen and/or water within the spreading film was the driving force responsible for such creepage.

Completely independently of the work of Hull and James [1], we have made similar observations as part of an extensive study of alkaline cell leakage and now present these findings in the light of the above disclosures.

The extra-creepage takes the form of a slowly advancing thin liquid film moving up the electrode above the stationary meniscus. Such creepage has been monitored for up to two weeks with final spreading distances being in excess of 2.5 cm above the meniscus. Russian workers [2] observed similar creepage distances of alkaline electrolyte along steel electrodes but gave no explanation to their findings.

These relatively large spreading distances cannot be explained by double layer and contact angle theories (electrocapillarity) since the maximum creepage distance allowed by such theories is only about 0.38 cm, which would correspond to complete wetting of the electrode (i.e. zero contact angle). In practice electrocapillary creepage varies between 0.2–0.3 cm depending on the charge of the electrode [3]. Further, the electrocapillary phenomenon is essentially a static effect and does not account for the time dependence encountered with extra-creepage.

Stable thin electrolyte films above the normal meniscus boundary have been observed previously on planar gas diffusion electrodes in both acid and alkaline media [4–8]. Within these films a large portion of the charge transfer current is located since the transport of gaseous molecules to the electrode surface is less hindered in such regions. For the case of oxygen reduction in alkaline electrolyte the electrochemical process is

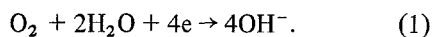

It is clear that for such a reaction to proceed there must be continuous circulation of water between the film and the bulk electrolyte. Although the

actual mode of water transport is not fully understood there appear to be two possible mechanisms, both of which rely on the fact that the nature of the electrochemical reaction necessitates the establishment of a concentration gradient between the bulk electrolyte and the film.

Benniot and Tobias [8, 9] concluded that sufficient water could be supplied to the film by condensation from the vapour phase, the process being made possible by the differences in water vapour pressure associated with the concentration gradient. However, Lightfoot and Ludviksson [10] argued that a more efficient process was one utilizing the Marangoni effect which would operate as a consequence of the surface tension gradient which must accompany the concentration inequalities across the film and meniscus.

Since the potential of the negative electrodes in alkaline batteries is sufficiently cathodic to allow electrochemical oxygen reduction and in the case of cells utilizing zinc anodes, water reduction, the above modes of water transport would be expected to occur within any spreading films and thus possibly form the basis of a mechanism for alkaline cell leakage.

In this paper the nature of extra-creepage and the factors which influence it have been investigated and a mechanism, based on the above discussion, proposed to account for the observations.

2. Experimental

2.1. Preparation of electrodes and solutions

All electrodes were constructed from high purity metal ($> 99.99\%$) and were in the form of rectangular plates of area $4\text{ cm} \times 2\text{ cm}$ and of 0.1 cm thickness. Their surfaces were polished with diamond paste to a scratch-free mirror-like finish. Nickel and tin electrodes were then cleaned with carbon tetrachloride and dried between filter papers, while the gold electrode was cleaned by immersion for 15 min in chromic acid before being thoroughly washed with distilled water and dried with filter papers.

All solutions were prepared from analar chemicals and triply distilled water. During preparation and before use all solutions were thoroughly degassed with nitrogen.

All apparatus was cleaned with chromic acid before use.

2.2. Apparatus and measuring technique

The essential features of the experimental apparatus are depicted in Fig. 1. Its construction was based on the design of Morcos [3].

The thermostatically controlled sealed perspex box enabled the atmosphere surrounding the working electrode to be controlled, while four dishes containing working electrolyte further ensured that equilibrium humidity conditions were established within the box. The electrochemical cell consisted of a 6 cm diameter teflon beaker with separate compartments for the reference (Hg/HgO) and platinum counter-electrodes, the latter compartment being open to the outside of the box to prevent any gaseous products liberated at that electrode from contaminating the atmosphere surrounding the cell.

A screw-thread arrangement allowed the box and electrochemical cell to be raised or lowered relative to the vertically mounted working electrode whose position remained fixed. In this way the flat liquid surface in the cell could be brought into contact with the bottom of the working elec-

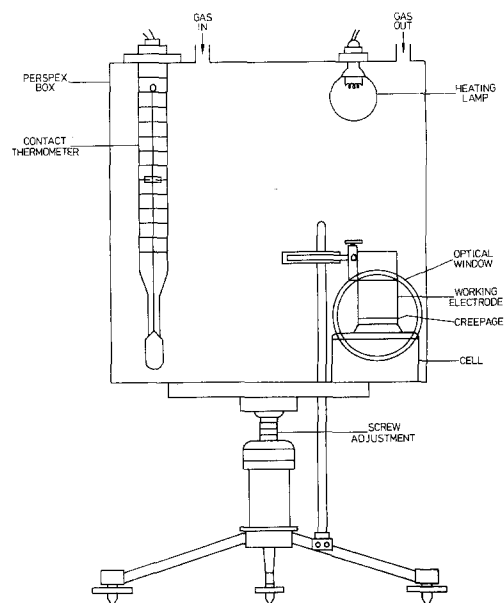

Fig. 1. Experiment apparatus (counter and reference electrodes not shown).

trode allowing a meniscus to form. An optical glass window mounted in the side of the box enabled the meniscus and extra-creepage heights to be viewed and measured with a precision travelling microscope.

The potential of the working electrode was controlled by a Chemical Electronics potentiostat type I.C. 20/0-5., while the current flow was measured as a potential drop across a standard resistance connected in series with the counter-electrode. In the following figures the current axes have been rationalized to correspond to the current flow per unit width of spreading film.

After allowing at least two hours for equilibrium conditions to be established, the extra-creepage height (Z) was monitored by periodically recording the position of the spreading front and the meniscus boundary with the travelling microscope.

3. Results

3.1. Electrocapillary creepage

As soon as the bottom of the plate electrode comes in contact with the liquid surface of the

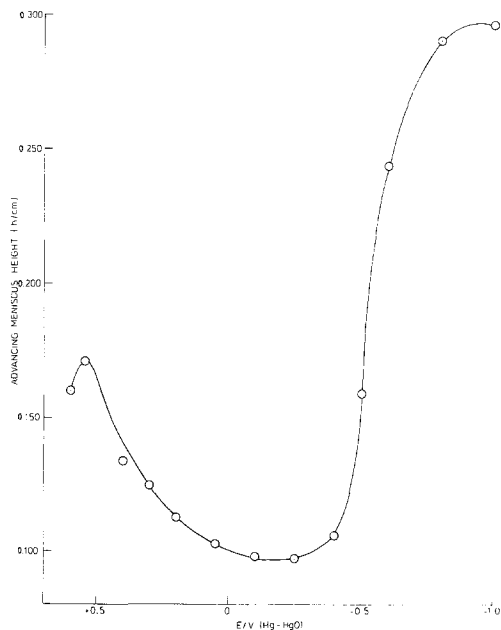

Fig. 2. Advancing meniscus height as a function of potential. Gold electrode in 30% w/w KOH. N_2 atmosphere. Temperature $30^\circ C$.

electrolyte a meniscus is formed, the height of which, for a gold electrode, is a function of the electrode potential as shown by Fig. 2. This well known electrocapillary effect results from variation of the charge of the electrode/electrolyte double layer with potential. The potential at the minimum in the meniscus height corresponds to the potential of zero charge of the metal, while the maximum heights occur at the more extreme cathodic and anodic potentials where there is a large excess of charge. There is little time dependence associated with this form of electrolyte creepage with equilibrium heights being established within a few minutes. Therefore, such a process cannot explain extra-creepage which is a dynamic phenomenon with creepage heights well in excess of 0.3 cm, the maximum associated with electrocapillarity.

3.2. Extra-creepage

At the more cathodic region of the electrocapillary curve, in addition to the intrinsic meniscus, extra-creepage first starts to become apparent. Above the initial three-phase boundary very fine droplets of liquid appear which enlarge and eventually coalesce to form a continuous liquid film. This film slowly advances up the electrode while the meniscus boundary quickly reaches its equilibrium values (Fig. 3).

No extra-creepage is observed on the anodic side of the electrocapillary curve.

3.2.1. Effect of potential and oxygen. The rate of advancement of extra-creepage increases with increasing cathodic potential as shown by Fig. 3 while from Fig. 4 it can be seen that the reduction currents generated at these potentials increase simultaneously with the advancing film. Since the bottom of the electrode is just touching the liquid surface in the cell, all the current must be generated in the meniscus and spreading film, therefore the increase in current must be associated with the increasing area of spreading film in contact with the electrode.

There are two possible electrochemical reactions that can give rise to these cathodic currents, either reduction of oxygen (Reaction 1) or water

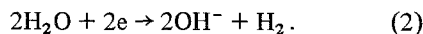

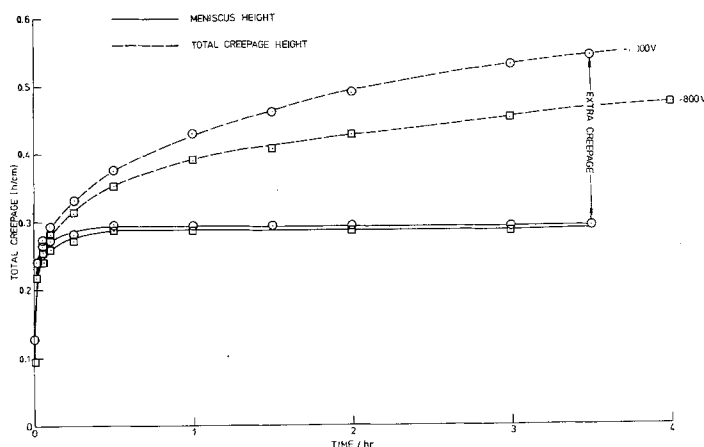

Fig. 3. Total creepage height as a function of time. Gold electrode in 30% w/w KOH. N_2 atmosphere. Temperature $30^\circ C$.

Both reactions have the same effect of consuming water and generating hydroxyl ions and since the reactions are known to occur within the spreading film a positive concentration gradient will be set up there relative to the bulk electrolyte.

For Reaction 2 the reversible potential at $30^\circ C$ (30% wt% KOH) is $-0.933 V$ (Hg/HgO), therefore at the lower cathodic potential ($-0.8 V$ in Fig. 4) Reaction 1 must be the source of the current despite the fact that the atmosphere surrounding the electrode is very low in oxygen content. However, even though the currents are extremely small, it does appear that extra-creepage is extremely sensitive to the presence of oxygen.

A clearer demonstration of the influence of oxygen on extra-creepage and cathodic current flow can be seen in Figs. 5 and 6. The nickel-plate electrode was maintained at a potential of $-0.920 V$ (the potential of the cadmium anode in

alkaline batteries) and the extra-creepage and reduction current monitored in the three different atmospheres. It is evident that at this particular potential oxygen reduction is responsible for the current flow and extra-creepage.

At potentials more negative than about $-0.930 V$ water reduction (Reaction 2) would also be expected to contribute to the current flow and thus possibly extra-creepage. The fact that this happens can be seen from Fig. 7 where increased extra-creepage and current flow are observed on nickel in a nitrogen atmosphere at a potential of $-1.150 V$.

In alkaline batteries utilizing zinc anodes the negative sealing surface takes up a potential close to $-1.350 V$, the exact value depending on the nature of the metal surface. At this potential water reduction will be the predominant electrochemical reaction responsible for extra-creepage. Fig. 8

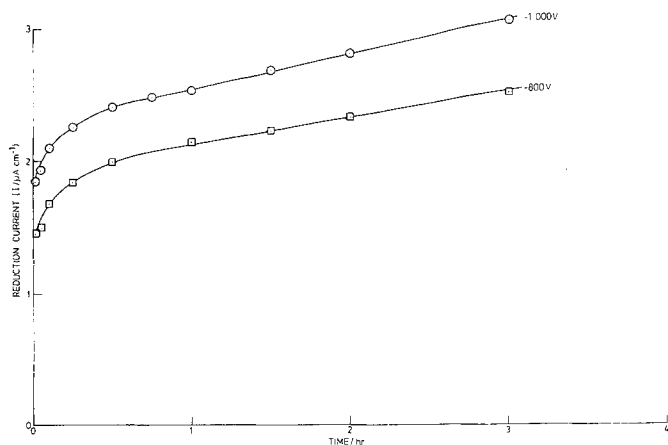

Fig. 4. Reduction current as a function of time. Gold electrode in 30% w/w KOH. N_2 atmosphere. Temperature $30^\circ C$.

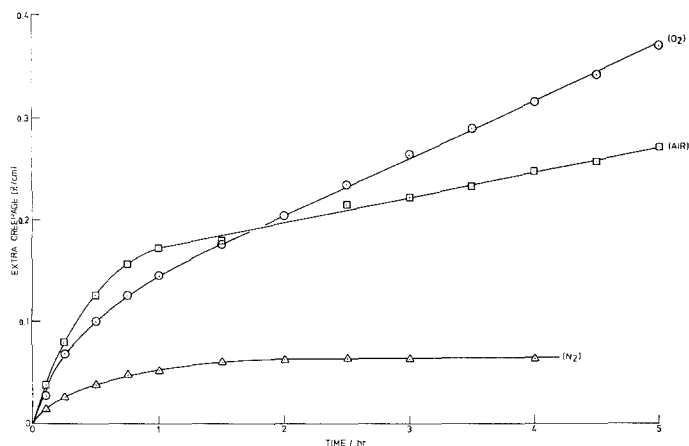

Fig. 5. Influence of atmosphere on extra-creepage. Nickel electrode in 30% w/w KOH. $E/V = -0.920$. Temperature 30°C .

shows the extra-creepage of 40% wt% KOH (9.90 M) at these more negative potentials on tin, a metal like gold, that has been used to plate alkaline battery components. The very small amount of extra-creepage observed at the rest potential can be attributed to the cathodic component of the corrosion current which must flow at that potential, while the extra-creepage at -1.354 V corresponds to that which would occur in an alkaline cell where the zinc anode was in contact with a tin surface.

3.2.2. Influence of electrolyte composition. The nature of the electrolyte has a marked influence on the rate of extra-creepage under conditions where both oxygen and water reductions prevail. From Fig. 9 it is evident that on both gold and tin surfaces at the potential they would achieve if contacted with a zinc anode there is a marked

reduction in the tendency of NaOH to creep compared to an equimolar concentration of KOH. In conjunction with the reduced creepage tendency of NaOH there is also a marked decrease in the current flow at the electrode. A comparison with Fig. 8 also reveals that the addition of ZnO (added to alkaline electrolyte to suppress cell gassing), reduces extra-creeping to a small extent.

According to Lightfoot and Ludviksson [12] the rate of creepage of liquid up a vertical metal surface is proportional to the term $1/\eta\rho$, where η and ρ are the viscosity and density of the liquid respectively. The same relationship is found for the case of equimolar concentrations (9.90 M) of NaOH, KOH and a 1:1 mixture of the two electrolytes (Fig. 10), where for the case of nickel, the rate of extra-creepage (dZ/dt) was obtained from the linear Z versus t plots (Fig. 5). However, since density changes are only small, viscosity is by far

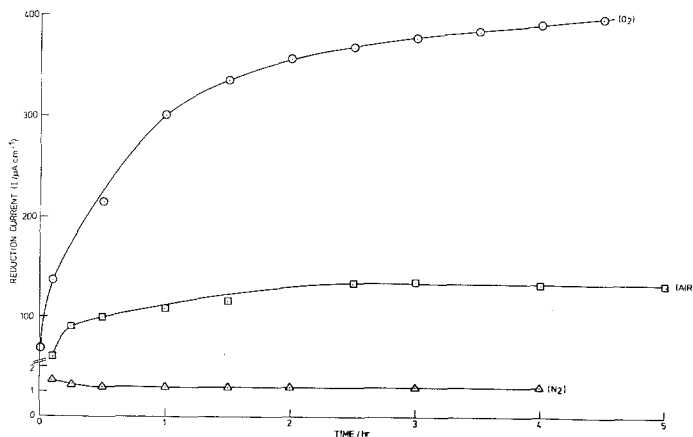

Fig. 6. Influence of atmosphere on reduction current. Nickel electrode in 30% w/w KOH. $E/V = -0.920$. Temperature 30°C .

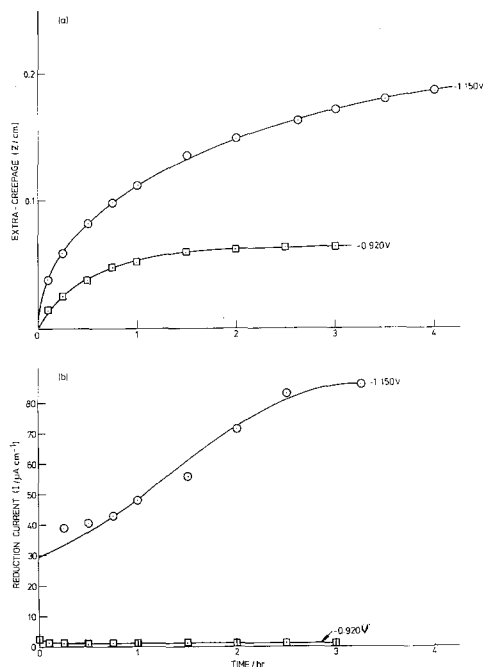

Fig. 7. Influence of potential on (a) extra-creepage (b) reduction current. Nickel electrode in 30% w/w KOH. N_2 atmosphere. Temperature 30°C .

the most important parameter controlling extra-creepage.

The enhanced creepage rates obtained on gold compared to tin surfaces (Fig. 9) may result from the former's lower hydrogen overpotential characteristics resulting in increased current flow (Fig. 11), although differences in surface preparation (polishing, cleaning chemical state) which cannot be quantified, may also be of importance.

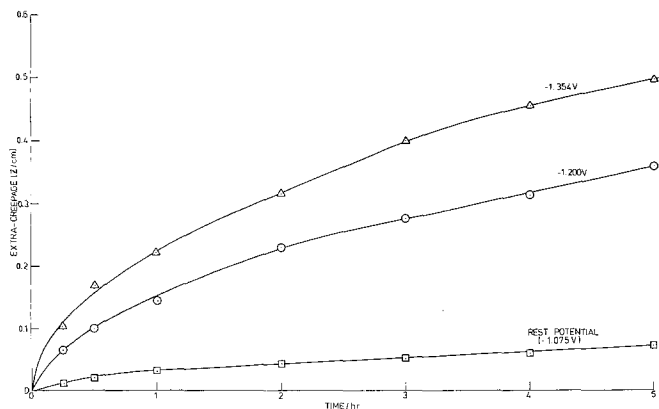

Fig. 8. Influence of potential on extra-creepage. Tin electrode in 40% w/w KOH. N_2 atmosphere. Temperature 30°C .

3.2.3. Long term extra-creepage. Although for the first few hours of an experiment it is often found that a near linear relationship between extra-creepage height and time exists, inevitably the rate of extra-creepage begins to decrease with time. However, an equilibrium state never appears to be reached even after a period of several days. This point is clearly illustrated in Fig. 12 where the long-term extra-creepage of battery electrolyte on gold and nickel surfaces are depicted. It is also clear from these long-term experiments that increasing the creepage path length in alkaline batteries will not in itself prevent leakage, at best only delaying it.

3.2.4. Influence of temperature. The dependence of extra-creepage on temperature is depicted in Fig. 13. The enhanced rates of extra-creepage with increasing temperature would be expected considering the lower electrolyte viscosities that must be associated with the more elevated temperatures.

4. Discussion

The observation that extra-creepage is associated with cathodic current flow and the fact that battery leakage only occurs at negatively charged surfaces highlights the importance of the nature of the electrochemical reactions occurring on the metal surfaces at the potentials operative in alkaline batteries. For alkaline batteries employing zinc anodes both oxygen (Reaction 1) and water (Reaction 2) electrochemical reduction would be expected to occur, while on cadmium cells only the former reaction will be of importance. Also,

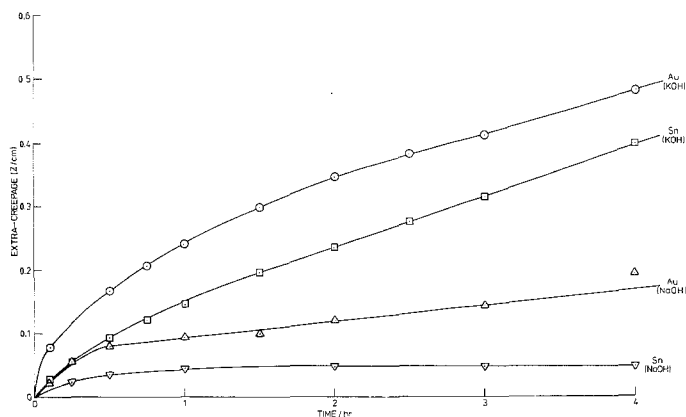
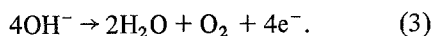

Fig. 9. Influence of electrolyte composition on extra-creepage. Gold and tin electrodes in equimolar concentrations (9.90 M) of NaOH and KOH containing 60 mg cm^{-3} zincate (ZnO). $E/V = -1.340$ (Au) and -1.354 (Sn). N_2 atmosphere. Temperature 30°C .

because a large part of the reductions are known to occur within the creepage film as shown by the tendency of the current to increase simultaneously with film height and by numerous studies [4–8] on planar gas diffusion electrodes, both reactions will have the effect of concentrating hydroxyl ions in the region of the meniscus and spreading film. The importance of these electrochemical reactions to extra-creepage can be further emphasized when consideration is given to the nature of the corresponding anodic reactions which do not produce extra-creepage or cell leakage. For alkaline solutions the main anodic reaction for a gold or nickel electrode will be the reverse of oxygen reduction, thus



Although this reaction may be expected to occur preferentially in a spreading film due to the ease with which oxygen could diffuse away from the electrode, it would have the opposite effect to the

cathodic reaction in that it would lower the hydroxyl ion concentration within the creepage film relative to the bulk electrolyte. It appears then that the mechanism for extra-creepage and cell leakage hinges on the generation of a concentration gradient between the spreading film and the bulk electrolyte.

Although the establishment of concentration gradients are known to stabilize thin electrolyte films on planar gas diffusion electrodes [8–10] they do not account for the spontaneous advancement of the film front over a previously unwetted electrode surface. However, optical studies have shown the advancement of much thinner ($< 0.05 \mu\text{m}$) primary films ahead of the main bulk spreading films during the creepage of both electrolytes [6] and non-electrolytes [11] along solid surfaces. These primary films are believed to be produced by a combination of multi-layer adsorption from the vapour phase and surface diffusion [11, 12]. Consequently, at the very initial stages of extra-creepage there will be

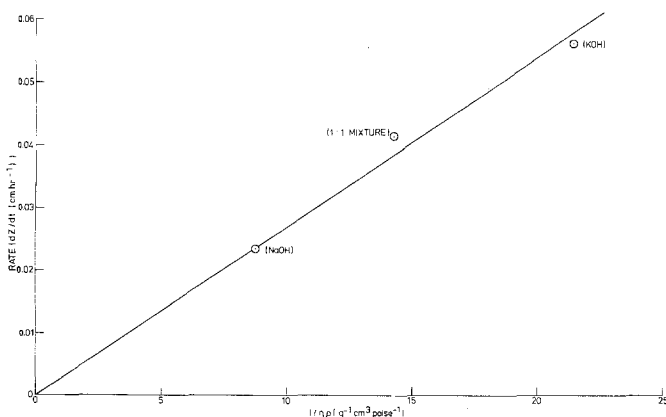

Fig. 10. Influence of viscosity and density on the rate of extra-creepage. Nickel electrode in equimolar concentrations (9.90 M) of NaOH, KOH and a 1:1 mixture. $E/V = -0.920$. O_2 atmosphere. Temperature 30°C .

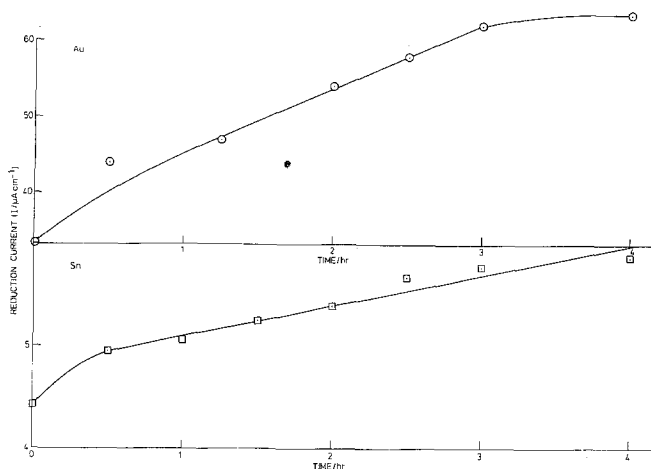

Fig. 11. Reduction current flow on gold and tin electrodes in 9.90 M (40% w/w) KOH containing 60 mg cm^{-3} zincate (ZnO). $E/V = -1.340$ (Au) and 1.354 (Sn). N_2 atmosphere. Temperature 30°C .

a very thin liquid film on the metal surface just above the meniscus, and within this primary film preferential oxygen and/or water reduction will occur since transport of oxygen to and hydrogen away from the electrode will be favoured in that region compared to the surface covered by the meniscus. The corresponding concentration gradient that will be generated will thus be able to stabilize a thicker secondary film (extra-creepage) which will slowly advance over the

electrode surface behind the primary spreading film.

In order to maintain an extra-creepage film and to allow it to advance further up a partially immersed electrode, water must be continuously supplied to the film firstly to replenish that which is being progressively consumed in the electrochemical reactions and secondly to allow the film to expand and thus advance over the electrode. The mode of water transport is obviously very important to the whole concept of extra-creepage and will now be considered.

Clearly, with non-equilibrium concentration conditions prevailing between the spreading film and bulk electrolyte, movement of water towards the region of highest concentration of hydroxyl ions would be expected by straightforward diffusion. However, calculations have shown [8] that such a process would require unrealistically large concentration gradients to supply even enough water to maintain very small reduction currents ($15 \mu\text{A cm}^{-1}$) let alone allow the film to expand and creep. Some other mode or modes of water transport must operate.

One such mechanism is water transportation via the vapour phase made possible as a consequence of the elevated alkaline concentration within the spreading film causing the equilibrium water vapour pressure (relative humidity) above that region to be lower than that surrounding the bulk electrolyte. The difference in relative humidities allows water to condense into the spreading film from the surrounding atmosphere thus enabling the electrochemical reactions to continue and the film to advance. This form of

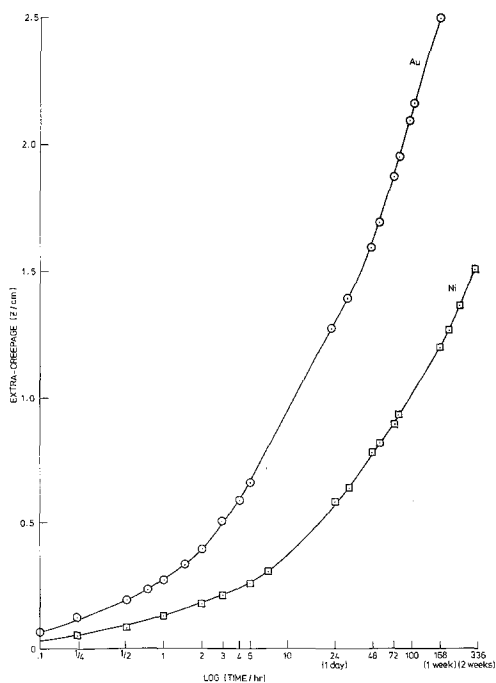

Fig. 12. Long-term extra-creepage on (a) gold electrode in 40% w/w KOH + 60 mg cm^{-3} zincate (ZnO). $E/V = -1.340$ and (b) nickel electrode in 30% w/w KOH. $E/V = 0.920$. Air atmosphere. Temperature 30°C .

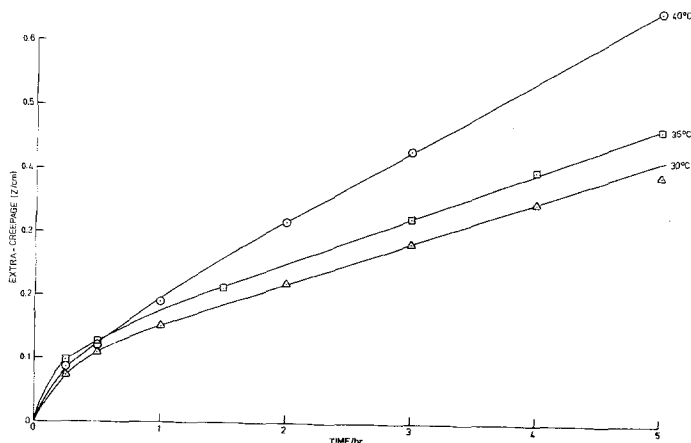

Fig. 13. Influence of temperature on extra-creepage. Tin electrode in 40% w/w KOH containing 60 mg cm^{-3} zincate (ZnO). $E/V = -1.354$. N_2 atmosphere.

water transport was suggested by Bennion and Tobias [9] to be capable of stabilizing stationary alkaline films on planar oxygen gas diffusion electrodes since the steady state concentration gradients required for such a process were much smaller than those necessary for a diffusion mechanism.

The rate at which water is transported via the vapour phase, and thus the rate of creepage, will depend on the difference in relative humidities between the creepage film and the surrounding atmosphere. Thus, if such a transport process is relevant to extra-creepage, an enhanced creepage rate should be observed when the humidity surrounding the electrode is deliberately increased. Fig. 14 shows this effect on nickel where, under galvanostatic conditions, extra-creepage was monitored in a normal humidity atmosphere and one super-saturated (relative to bulk electrolyte) with water vapour, this being achieved by replacing

the working electrolyte in the four dishes in the apparatus with pure water. Enhanced extra-creepage is observed under the higher humidity conditions although the increase in the actual rate is only small. However, if the only mode of water transportation was via the vapour phase then, under conditions of constant current and constant humidity (i.e. super-saturation), the rate of extra-creepage of equimolar concentrations of sodium and potassium hydroxide would be expected to be the same or very similar, since the relative humidities of both spreading films would be nearly the same while the surrounding atmospheres would be of identical humidity. The fact that the creepage rate for NaOH under super-saturated condition is still very much less than that for KOH under normal humidity conditions suggests that viscosity considerations must still be important and that a vapour phase transportation mechanism is not totally responsible for extra-creepage.

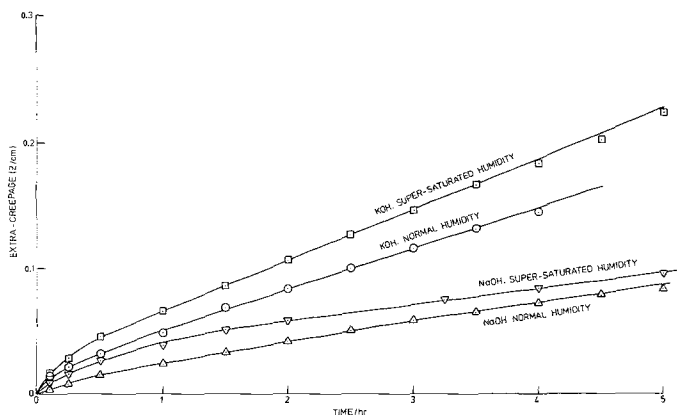

Fig. 14. Influence of humidity on extra-creepage. Nickel electrode in equimolar concentration (6.85 M) of NaOH and KOH. $I/\mu\text{A cm}^{-2} = 25$. O_2 atmosphere. Temperature 30°C .

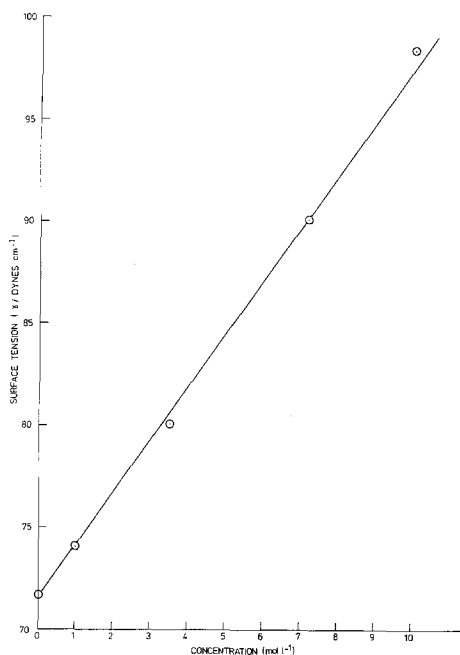

Fig. 15. Surface tension versus molarity for solutions of KOH. Temperature 30°C.

One further consequence of the electrochemically induced concentration gradients is that they will produce a corresponding positive surface tension gradient within the creeping film. Such surface tension inequalities will thus facilitate extra-creepage by causing electrolyte to be transferred from the bulk electrolyte into the spreading film by the well-known Marangoni effect [10, 11]. Also, since the surface tension of alkaline electrolytes (Fig. 15) changes rapidly with concentration, only very small concentration gradients are required to produce relatively large surface tension gradients and thus, according to Lightfoot and Ludviksson [10], much more efficient water transportation can be achieved on gas diffusion electrodes by the surface tension mechanism than by a vapour phase process. Further, since the Marangoni effect requires water transportation via the liquid phase, the main restraints for such a process will be viscosity and gravity forces, and in fact the relationship depicted in Fig. 10 is in agreement with the theory derived for the spreading of organic liquids up vertical surfaces under the influence of temperature-induced surface tension gradients [12]. This relationship takes the form

$$dZ/dt = 3\gamma^2/16\rho\eta g \quad (4)$$

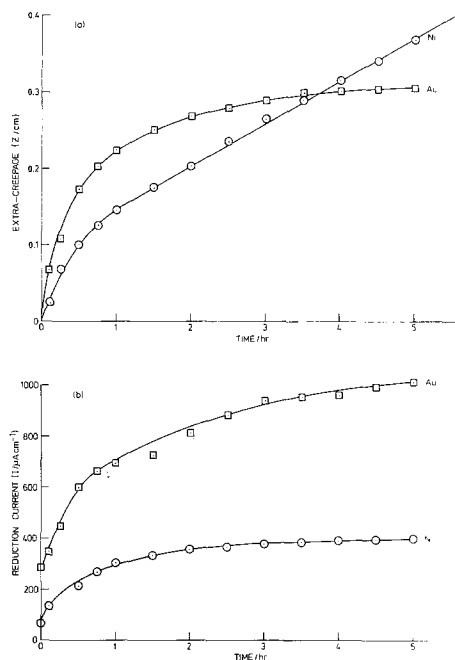

Fig. 16. Extra-creepage (a) and reduction current (b). Gold and nickel electrodes in 30% w/w KOH. $E/V = -0.920$. O_2 atmosphere. Temperature 30°C.

where γ is the surface tension gradient. If γ is constant then Equation 4 predicts a linear relationship between Z and t ; a correlation which is found experimentally.

It is probable that *both* water transportation mechanisms operate to some extent during extra-creepage with the experimental conditions (namely humidity) determining which mechanism predominates at any particular time.

However, in their report Hull and James [1] did not consider the Marangoni effect as a mode of water transport, instead these authors postulated the vapour phase process and, at low alkali concentration, a mechanism involving electro-osmotic movement of liquid. Our findings suggest that water transport via the vapour phase is not predominant and that a more efficient process is one involving the Marangoni effect.

Regardless of which water transportation mechanism is in operation increased current flow would, on first appearance, be expected to increase the rate of extra-creepage. However, according to Fig. 16 this appears not to be the case where, apart from an initial period, the rate of extra-creepage on the nickel is greater than that on gold despite the fact that the latter metal can

support much higher currents at the same electrode potential. There are two factors which can explain this apparent discrepancy. Firstly, the higher the current flow within the spreading film the more water that must be transported to that region so that the electrochemical reaction can be maintained. Thus, if the current flow is too high the spreading film is unable to expand and advance since all the transported water is needed to maintain the reactions. Secondly, and probably the more important factor is that as the concentration of the spreading film exceeds about 7.0 M for KOH or 4.5 M for NaOH its conductivity will begin to decrease, so that as the extra-creepage film advances its electrical resistance increases. This increase in resistance will be accompanied by an increase in the IR drop across the film, the drop being greater the higher the current flow. For the case of gold the IR drop within the spreading film is appreciable so that the electrochemical reaction is unable to be maintained very far into the creepage film, while on nickel, where the currents are smaller, the IR drop is not so severe and thus the electrochemical reaction can proceed further into the spreading film. Further, the work of Bennion and Tobias [8] has shown that within thin electrolyte films on nickel a fairly even distribution of current extending over 2 cm above the intrinsic meniscus is found; while on silver, which like gold can support higher oxygen reduction currents than nickel, the current distribution is concentrated much nearer the meniscus and does not extend far into the film. If, due to IR polarization the current is unable to extend far above the meniscus, further extra-creepage will not be possible. Therefore for systems where current flow is high the rate of extra-creepage becomes controlled by the rate of consumption of water and by the IR drop within the spreading film.

5. Conclusion

The driving force for alkaline cell leakage has been established to be the electrochemical reactions

occurring on the negatively polarized surfaces of the battery. Since both reactions occur preferentially within the spreading film, they increase the alkaline concentration in that region relative to the bulk electrolyte and thus allow water transportation into the film either by a surface tension driven mechanism (Marangoni effect) or by condensation via the vapour phase. The creeping film can then expand and advance further over the electrode surface.

Prevention of alkaline leakage in cadmium cells can be achieved by adequate sealing against the ingress of oxygen, while for zinc cells in addition to sealing against oxygen an inhibition of the water reaction must also be achieved before this electrochemical form of cell leakage can be prevented.

Acknowledgement

The authors wish to thank the Directors of the Ever Ready Company (Holdings) Ltd, for permission to publish this work.

References

- [1] M. N. Hull and H. I. James, *J. Electrochem. Soc.* **124** (1977) 332.
- [2] R. V. Boldin, S. N. Sushentsova and W. W. Milyumin, *Sb. Rab. Khim. Isotochnikom. Toka Vses. Nauch. Issled. Akk. Inst.* **1** (1972) 161.
- [3] I. Morcos, *J. Electroanalyt. Chem.* **62** (1975) 313.
- [4] H. J. R. Maget and R. Roethlein, *J. Electrochem. Soc.* **112** (1965) 1034.
- [5] F. G. Will, *ibid.* **110** (1963) 145.
- [6] R. H. Muller, *ibid.* **113** (1966) 943.
- [7] Yu. A. Mazitov, K. I. Rozental and V. I. Veselovskii, *Russ. J. Phys. Chem.* **38** (1964) 234.
- [8] D. N. Bennion and C. W. Tobias, *J. Electrochem. Soc.* **113** (1966) 589.
- [9] *Idem*, *ibid.* **113** (1966) 593.
- [10] E. N. Lightfoot and V. Ludviksson, *ibid.* **113** (1966) 1325.
- [11] W. D. Bascom, R. L. Cottingham and C. R. Singleterry, *Adv. Chem. Ser.* **43** (1964) 355.
- [12] V. Ludviksson and E. N. Lightfoot, *Amer. Inst. Chem. Engineers J.* **17** (1971) 1166.